

G-Tray™

Stainless Steel Cavity Tray Systems

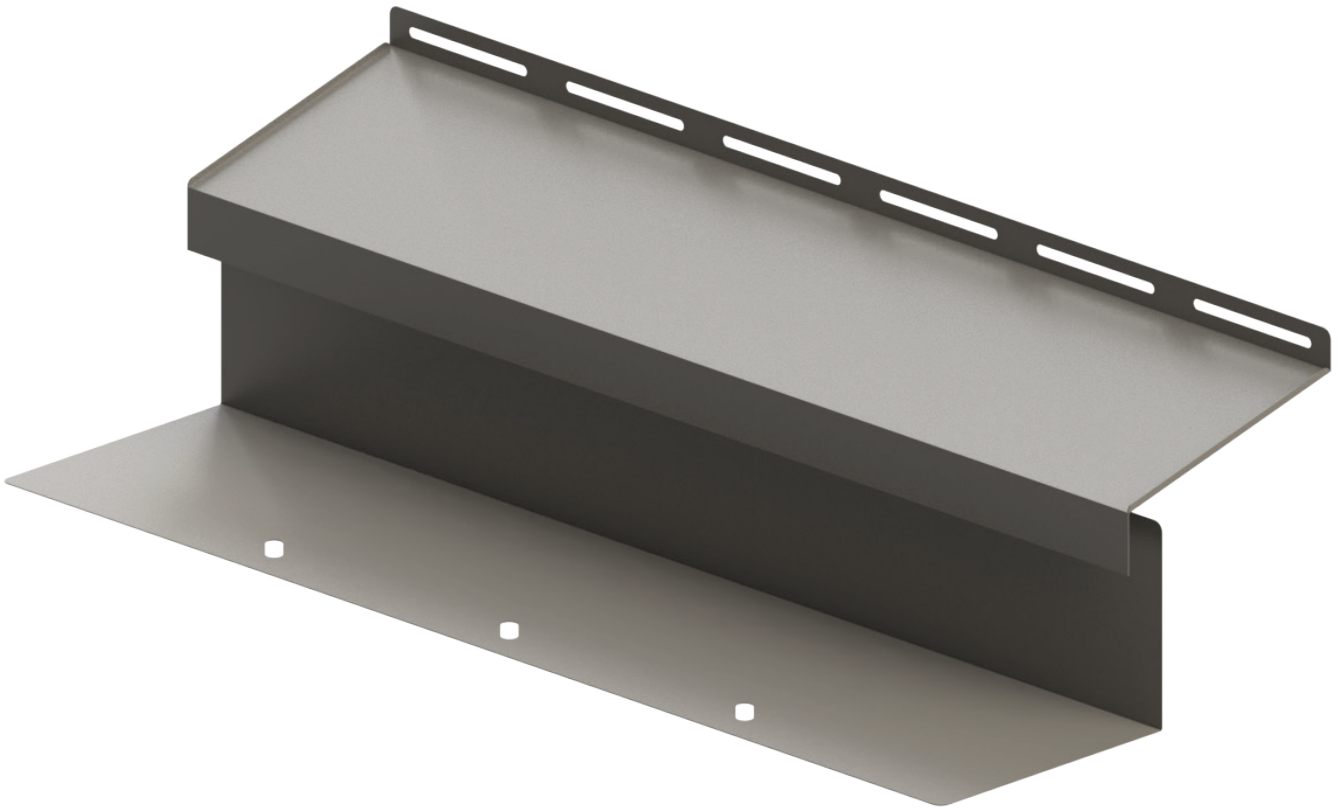

Installation Guide
January 2024



G-Tray™ - Stainless Steel Cavity Trays

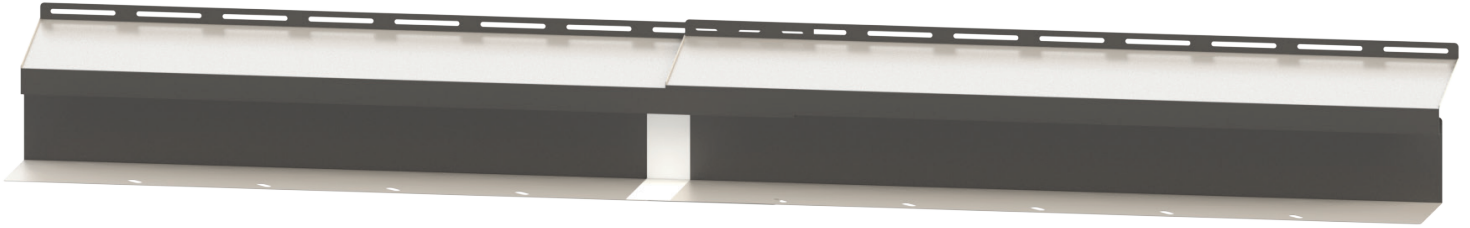

G-Tray™ Installation

The following installation guide demonstrates the approved installation process for the G-Tray™ Stainless Steel Cavity Tray system.

The correct use and installation of an ACS G-Tray™ is critical for the function, durability and long-term performance of the system. G-Tray™ cavity trays must be installed using ACS Stainless Steel tek screws/Duopower Concrete Fixings and Butyl tape joints.

Installation guidance for:

- GT1/GT2
- LGT (Lintel G-Tray™)
- Tray Stopends

Jointing

The G-Tray™ system requires Butyl tape to seal the system and prevent water ingress into the cavity or structure. The jointing method has been independently tested for this specific type of installation by a third party.



Butyl tape

- Single-sided Butyl tape, as specified.
- Double-sided Butyl tape, as specified.

Butyl tape is not to be installed in temperatures below 5°C.

Fixing types

The G-Tray™ system can be fixed to a SFS system, or a concrete/blockwork structure. The fitting process is exactly the same, however the position of the fixings can change slightly. This is to ensure the concrete fixings are not installed directly into a mortar joint and tek screws are fixed into studwork when acting as a load-bearing restraint.



5.5 x 50mm stainless steel tek screw (to SFS)



5.5 x 55mm stainless steel concrete screw (to blockwork or concrete)

G-Tray™ - Stainless Steel Cavity Trays



G-Tray™ installation guide – GT1 / GT2 units

Always refer to the approved ACS layout/section drawing supplied with your G-Tray™ system for setting out and location information.

Ensure that all surfaces are clean and dry prior to installation. Any mortar that falls onto the tray behind the brickwork should be cleared.

Step 1

When placing the GT1, check its unique reference number and place the tray as shown on the setting out drawings provided. Always ensure GT1 units are installed with a slight decline towards the external face of masonry to ensure that water runs towards said external face.

The horizontal GT1 unit must be laid on a fresh bed of mortar and extend the full length of the external leaf, including corners, reveals or any special setting out.

Step 2

The GT1 should be installed 5mm offset from the outer edge of the brickwork.

Remove the film from one side of the Butyl double-sided strip and stick along the side edge, ensuring it is fully adhered to the GT1 and that it does not overlap the end of the tray (see Fig. 1)

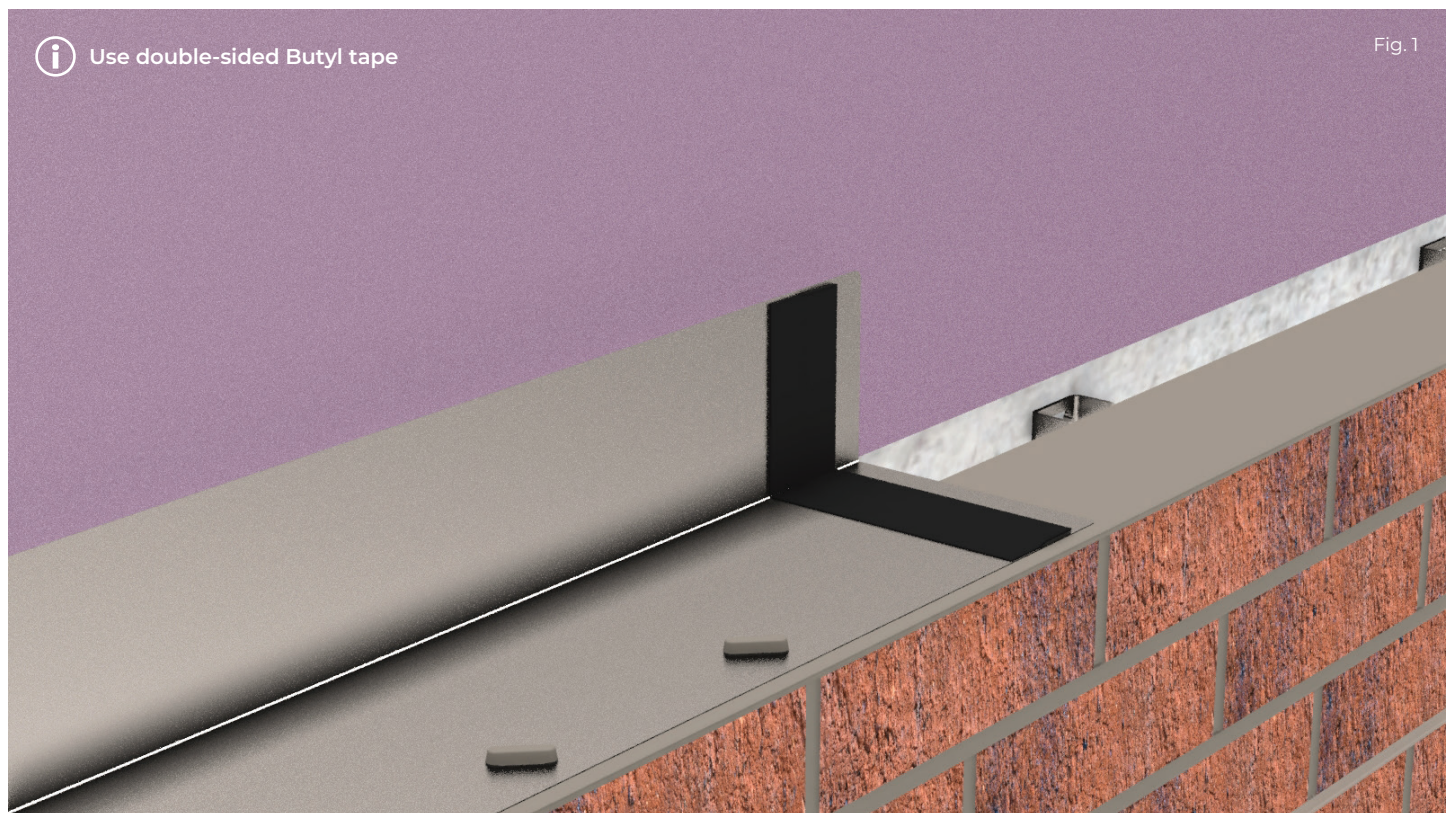

G-Tray™ - Stainless Steel Cavity Trays



Step 3

Remove the remaining film from the double-sided Butyl tape already adhered to the GTI unit and then place another GTI on top with a **minimum overlap of 50mm**.

Each GTI unit should be installed 5mm offset from the external face of the masonry. Ensure the Butyl tape is fully adhered to both GTI units (Fig. 2).

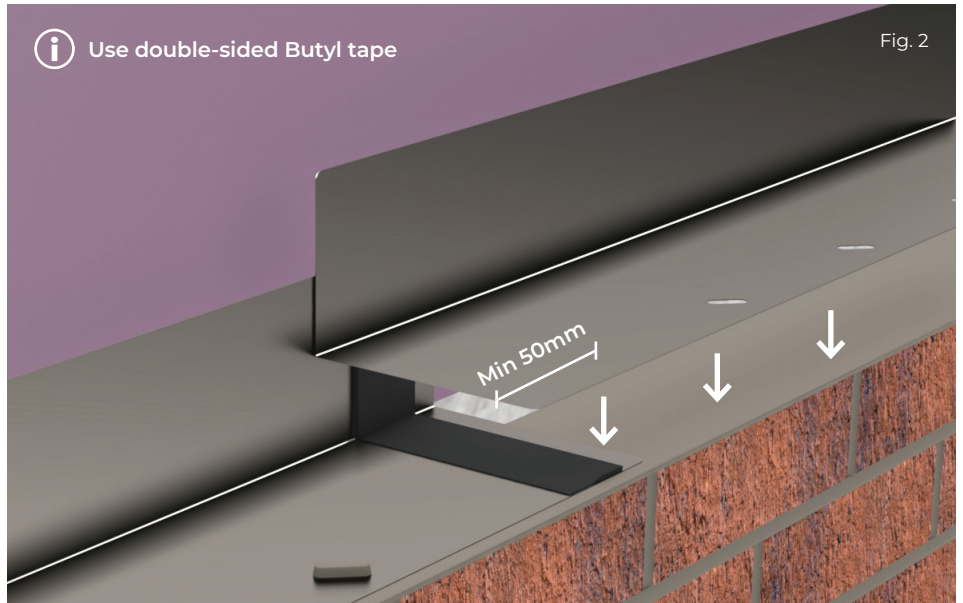

Step 4

Place a strip of single-sided Butyl tape, half overlapping both GTI units to ensure a waterproof joint. Ensure the Butyl tape is fully adhered to both GTI units, creating a waterproof joint (Fig. 3).

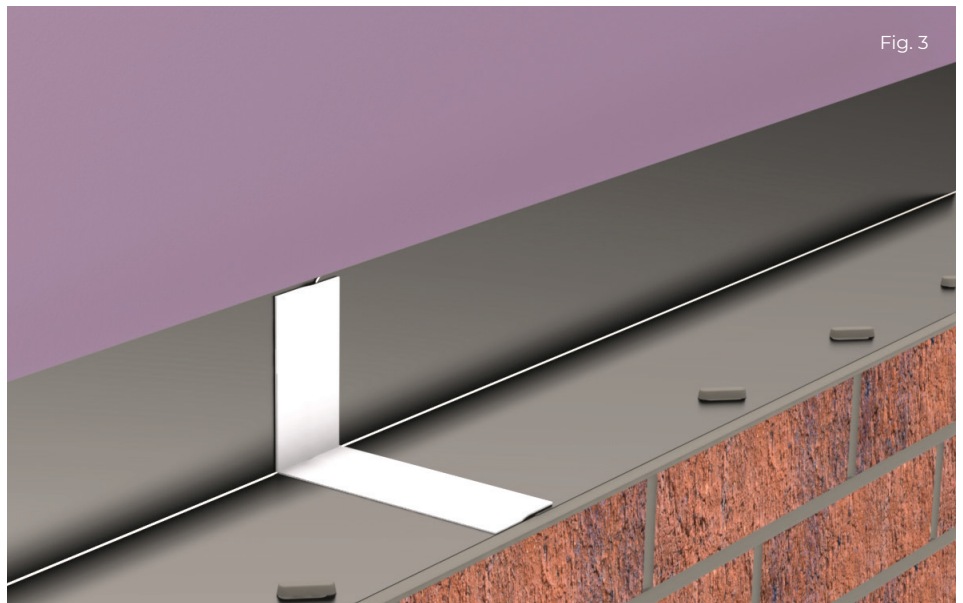

G-Tray™ - Stainless Steel Cavity Trays



Step 5

Before installing the second part of the system (GT2), it is recommended that an evaluation of the SFS stud positions is conducted.

Studs can be found by marking out sheathing board joints and fixing positions by using a stud detector.

Place GT2 profiles above GT1 units ensuring that the downward lip is outbound of the GT1 upstand. This will ensure any water falling upon the GT2 will drain down onto the GT1. A minimum of as 20mm vertical gap should be left as per the 'typical section' shown in this guide. The movement and tolerance report for the building should be consulted for if a larger figure should be used.

For concrete/block installation, it is recommended that you pre-drill the identified fixing position for ease of installation (Fig. 4).

The angled upstand lip of the GT1 unit in the cavity must be laid behind the lower planar section of the GT2 in ALL instances (Fig. 4a).



Fig. 4

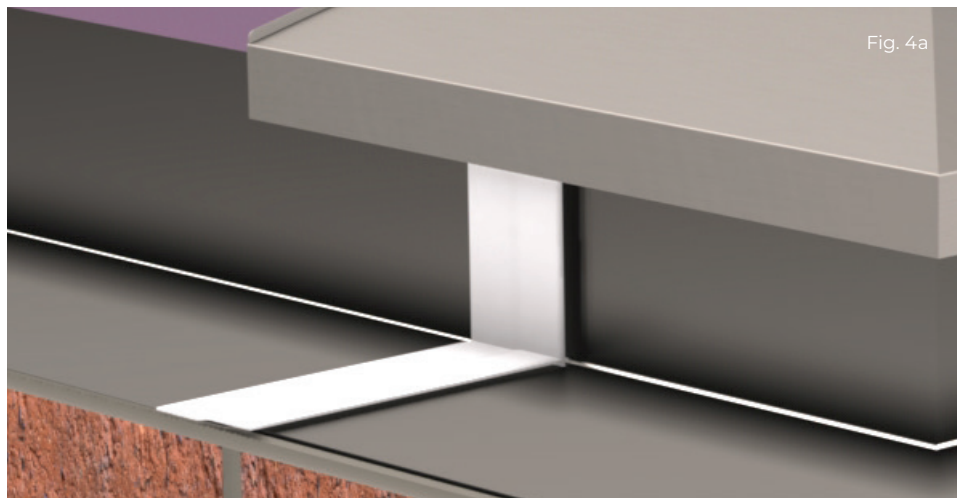

Fig. 4a



Note
Fixing into
concrete/blockwork

In some instances, G-Tray™ may need to be installed onto a concrete structure or blockwork. The same fitting procedure will apply. However, where tek screws are shown, it is recommended to use **Stainless Steel Concrete Screws**, ensuring the correct drilling and clearing procedure as defined by the fixing manufacturer is followed.

When installing G-Tray™ using concrete fixings it is recommended to use two fixing per sheet, using the first and last pre-cut fixing slot where possible, working inwards to an available slot when overlapping blocks the fixing access, or the fixing point falls on a mortar joint.

G-Tray™ - Stainless Steel Cavity Trays



Step 6

Beyond the standard range of the component an additional horizontal tolerance of +/-12mm is included.

To prevent thermal bridging, the GT2 unit must not touch the GT1 once installed.

The standard vertical distance between GT1 and GT2 units is 20mm. (Fig. 5)

However, reference should be made to any values set out in the project design engineer's movement and tolerance report as this figure may need to be increased accordingly.

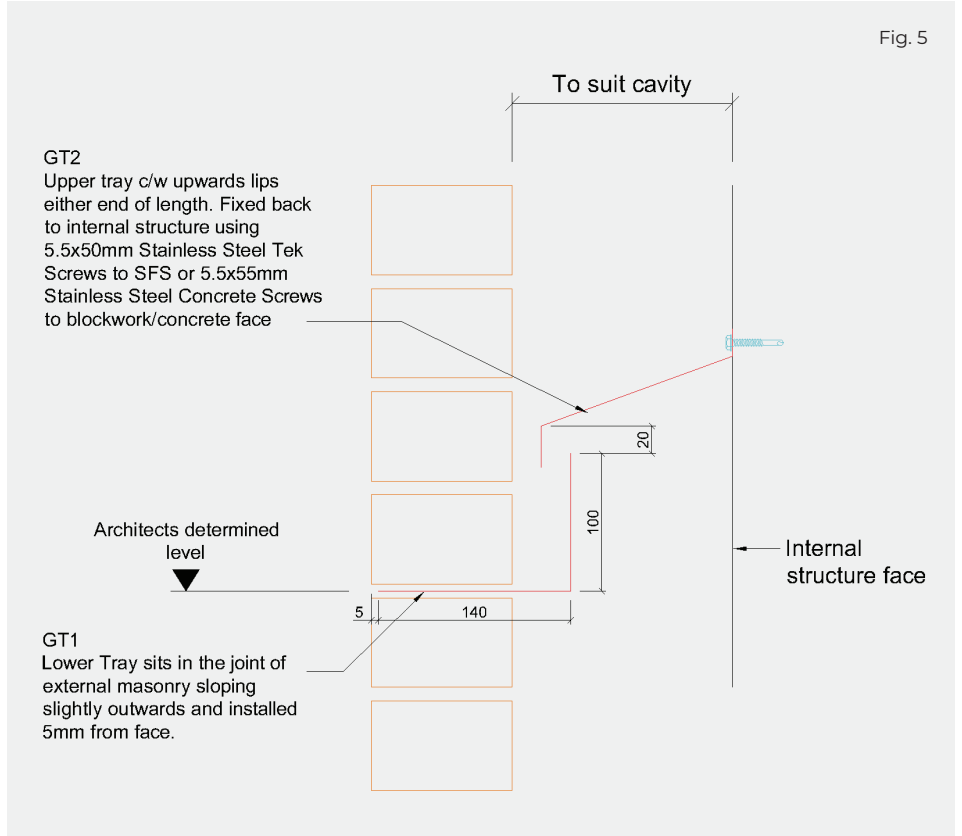

Step 7

To secure the GT2 units in place, use ACS approved tek screws, fixing through the slots within the upstand to the internal structure. The GT2 unit should be fixed at each stud position with **a minimum of two fixings per tray**. On shorter lengths (under 600mm), this may require two fixings into one stud.

Additional tek screws can be used to ensure joints/ends align fixing back between studs for restraint purposes only (Fig. 6).

Remember, the GT1 and GT2 must not touch.

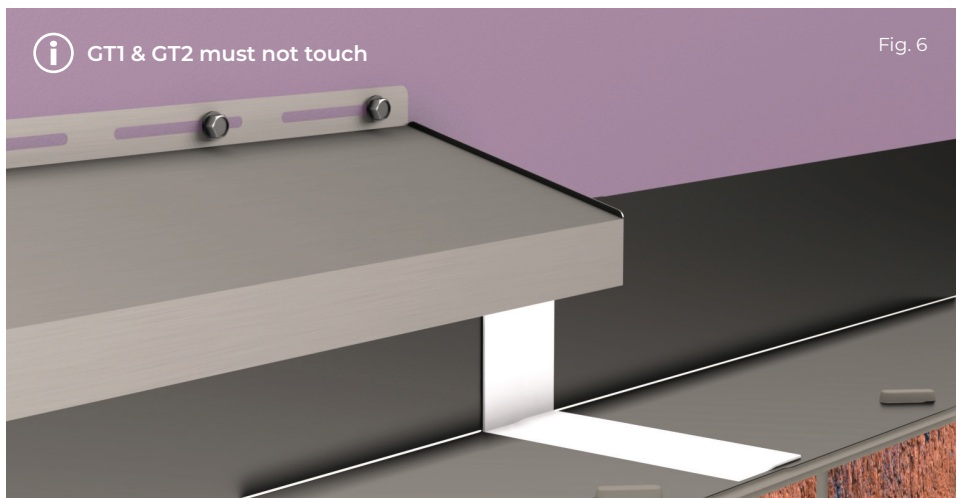

G-Tray™ - Stainless Steel Cavity Trays

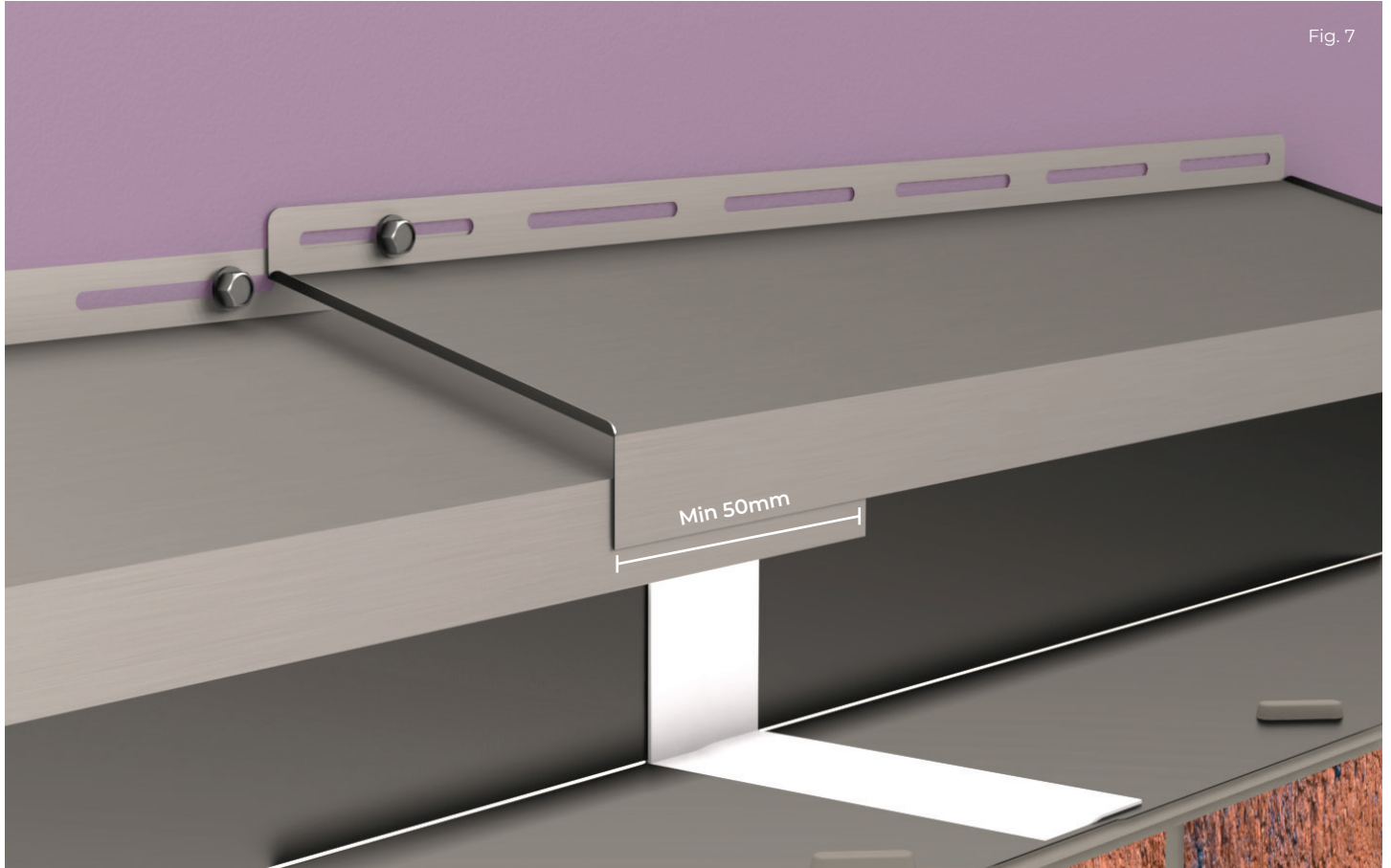

Fig. 7

Step 8

Install the next GT2 unit with a **minimum of 50mm overlap**. To assist with fixing, the top GT2 unit may be installed up to 20mm higher than the first unit (Fig. 7.)

Step 9

Repeat steps 1-8 to continue the installation, referring to any drawings provided.

Step 10

Once both GT1 and GT2 units are successfully installed, a fresh bed of mortar may be applied to the GT1 unit.

Step 11

Install weep holes/vents along the GT1 unit at the industry-specified centres to allow for water collected by the G-Tray™ system to be expelled from the cavity.

Note

LGT (Lintel G-Tray™) installation overleaf

G-Tray™ - Stainless Steel Lintel Cavity Trays



Fig. 8

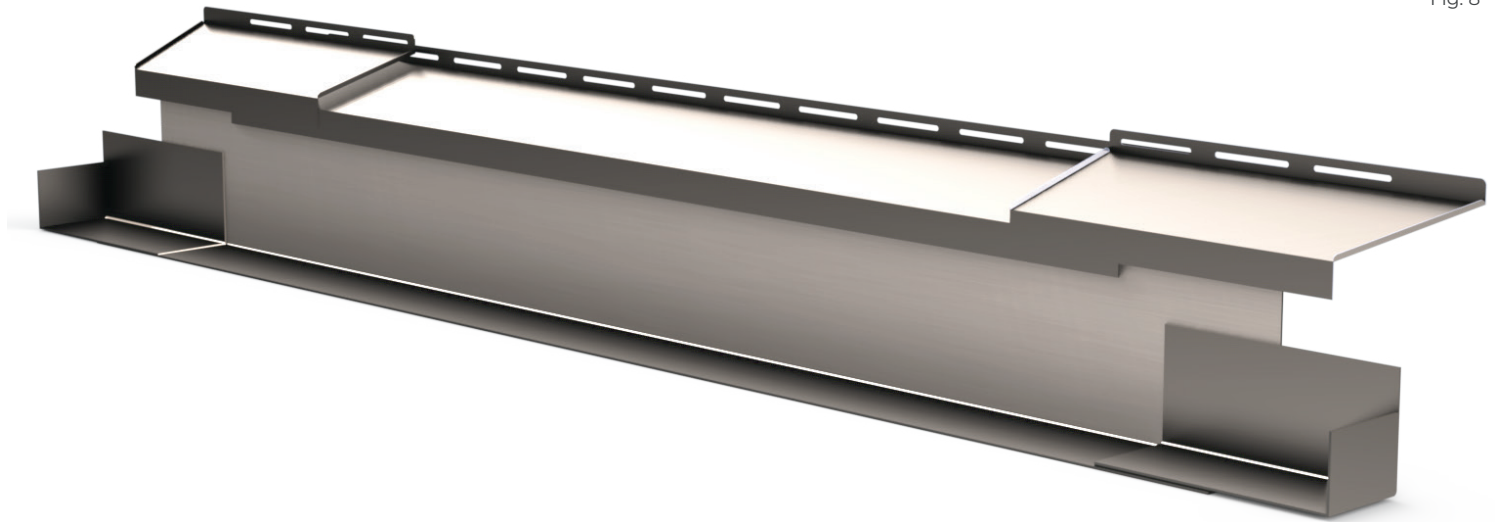

LGT (Lintel G-Tray™) cavity tray over opening

Always refer to any ACS drawings supplied with your G-Tray™ system for setting out and location information.

Ensure that all surfaces are clean and dry prior to installation

The ACS Lintel G-Tray™ is **only** suitable for use with stainless steel 'L' type lintels. If the lintel is not stainless steel, or a 'C' type, then a separate GT1/GT2 G-Tray™ will be required in the next available brickwork course above.

Step 1

When installing the G-Tray™ system, check its unique reference number and place the tray as shown on any drawings provided.

Ensure the G-Tray™ unit projects past the end of the lintel by at least 25mm. Where cavity closers are used, a minimum projection of 25mm must be achieved.

If a combination of cavity tray and stainless steel lintels have been specified, it is imperative that complete covering of the top of the reveal and vertical DPC is provided.

Place weep holes above the GT1 to allow water collected by the G-Tray™ to escape and continue to build (Fig. 9 - overleaf).

G-Tray™ - Stainless Steel Lintel Cavity Trays



Step 2

When installing the G-Tray™ with stainless steel 'C' type lintels, follow the standard fitting guide for GT1/ GT2 trays. However, consideration must be made when bed joint reinforcement may share a common location to both the lintel top leg and the GT1 joint location.

Step 3

When installing the G-Tray™ with stainless steel with 'L' type lintels, follow the standard fitting guide from Step 5 onwards. The GT1 unit is not required as the lintel is used in place of the GT1.

Ensure the lower lip of the LGT is located between the lintel upstand and the rear face of the brickwork.

Step 4

Install weep holes/vents along the GT1 unit at industry-specified centres to allow water collected by the G-Tray™ to be expelled from the cavity.

25mm min.

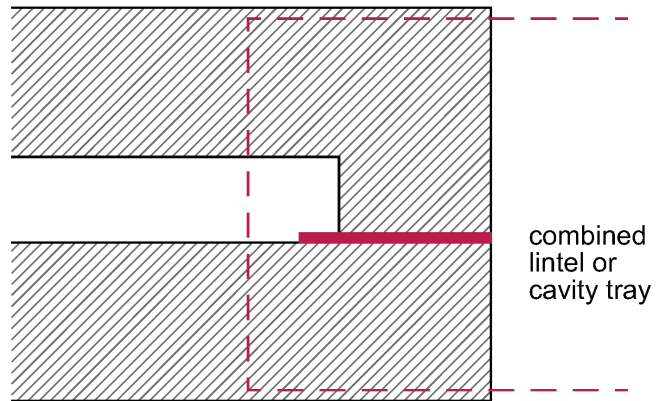

Fig. 9

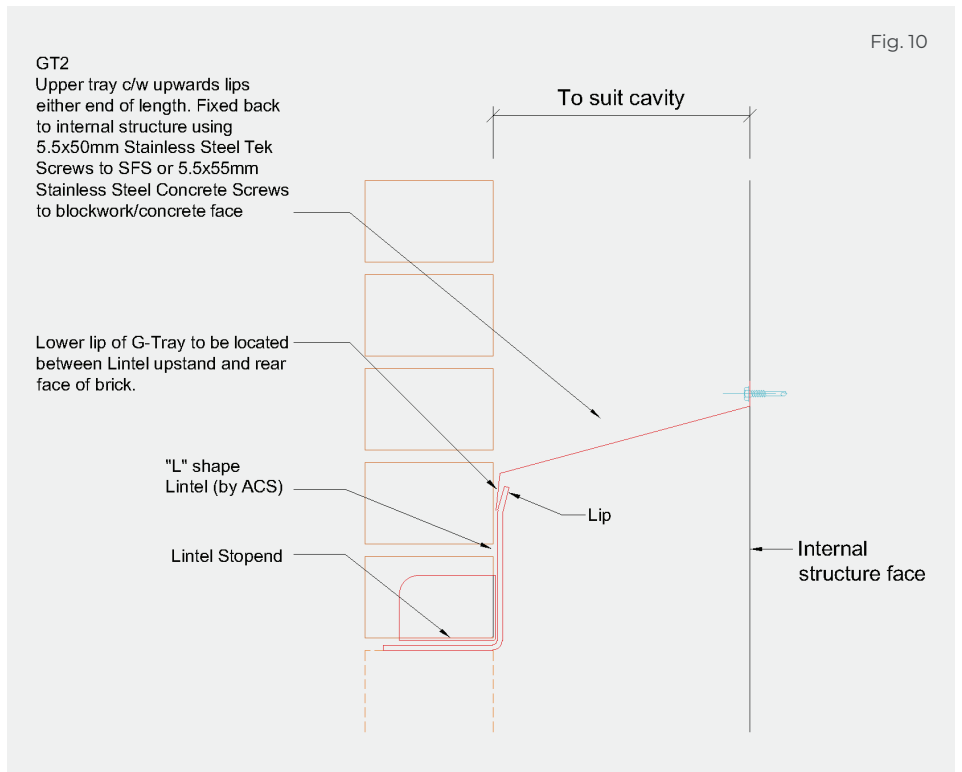

Fig. 10

G-Tray™ - Stainless Steel Cavity Tray Stopends



G-Tray™ installation guide – Stopends

Ensure that all surfaces are clean and dry prior to installation and only use G-Tray™ STOPENDS when there is a discontinuity or interruption of the G-Tray™ system.

Step 1
Use G-Tray™ STOPENDS when there is a discontinuity or interruption of the G-Tray™ system.

Step 2
Positioning of the STOPEND is dependant on the position of the vertical perpendicular course(s).

When the perpendicular course lands outside of the GTI unit (or the 'L' shape lintel), place the STOPEND as shown in Fig. 11, ensuring a **minimum of 50mm overlap**.

Step 3
Remove the film from one side of the double-sided Butyl tape and stick the Butyl tape along the side edge (Fig. 11).

Ensure the tape is fully adhered to the GTI. The tape should not overlap the end of the tray.

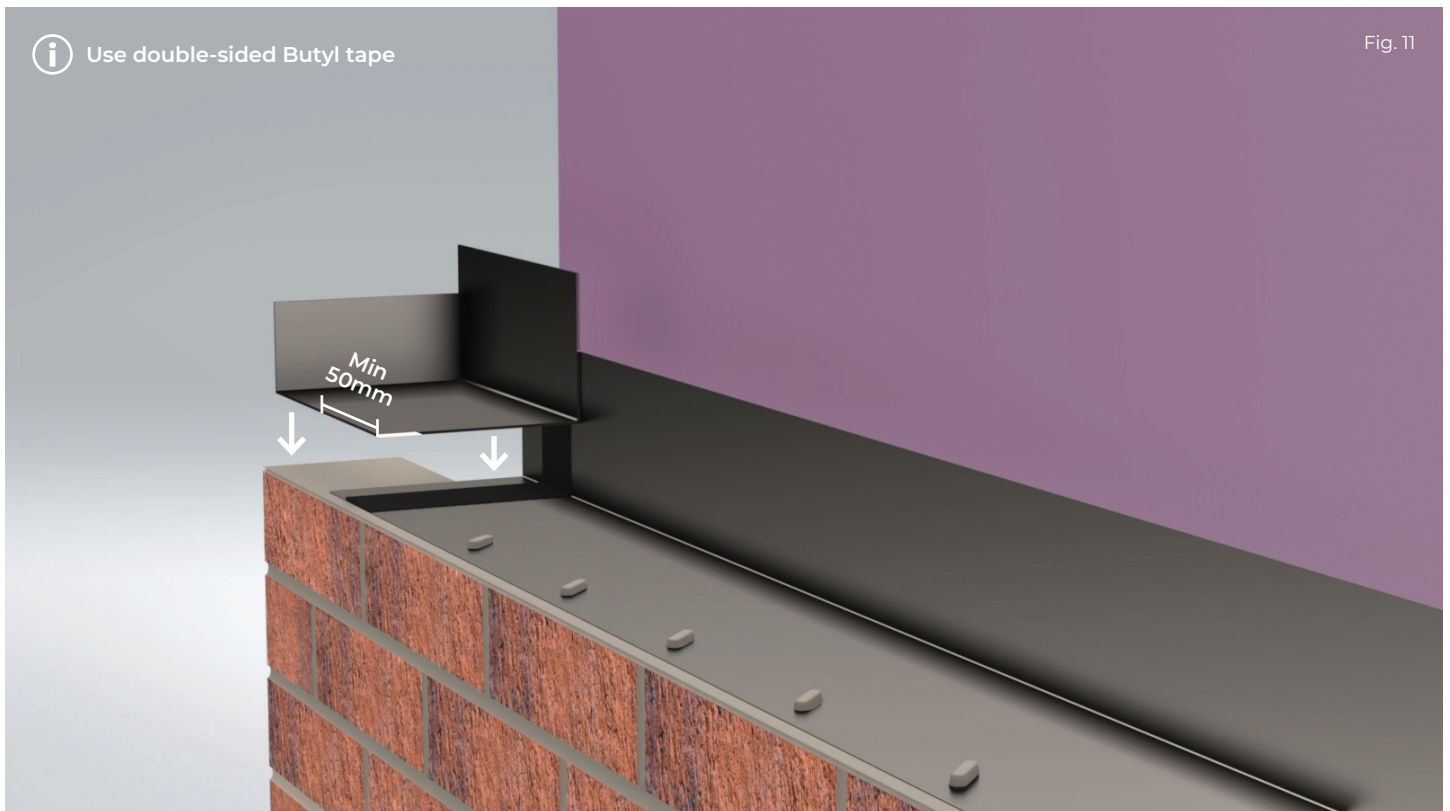

G-Tray™ - Stainless Steel Cavity Tray Stopends



Step 4

Remove the remaining film of the double-sided Butyl tape already adhered to the GT1 or 'L' type lintel unit and then place the STOPEND on top, ensuring a **minimum overlap of 50mm** (Fig. 12).

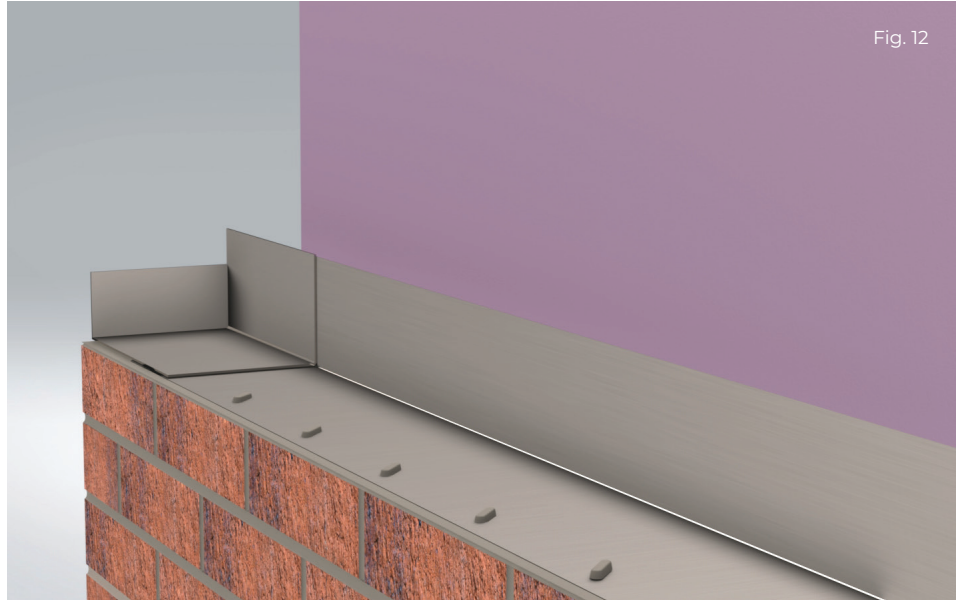

Fig. 12

Step 5

Place a strip of single-sided Butyl tape, half overlapping both GT1/'L' type lintel units and the STOPEND to ensure a waterproof joint.

Ensure the Butyl tape is fully adhered to both units, creating a waterproof joint (Fig. 13.)

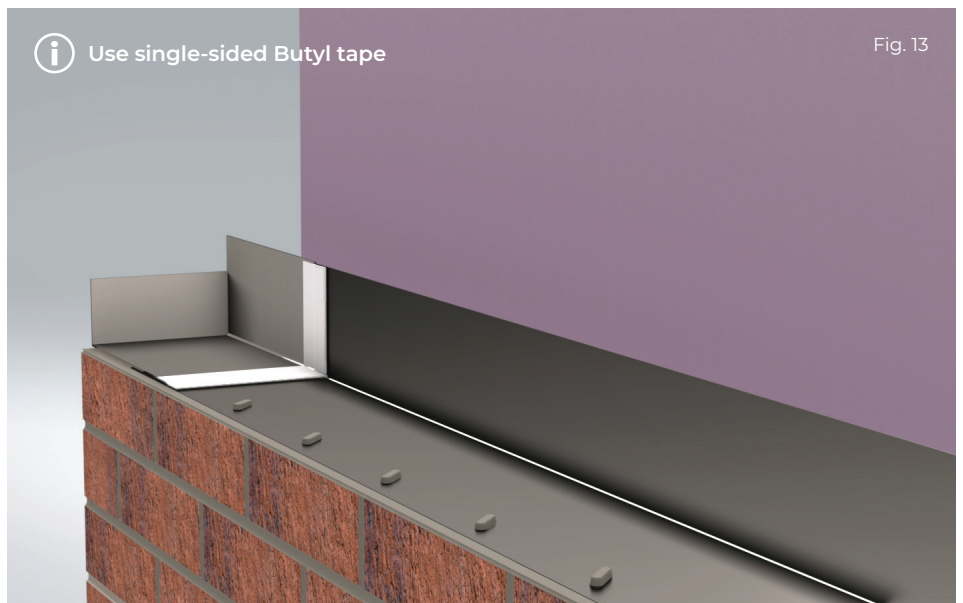

Fig. 13



G-Tray™ - Stainless Steel Cavity Tray Corners



G-Tray™ installation guide – Corners (GTIC/GT2C units)

Always refer to any drawings supplied with your G-Tray™ system for setting out and location information. The installation process for internal and external corners is the same. For ease, we have provided installation guidance for external corners. Ensure that all surfaces are clean and dry prior to installation.

Step 1

When placing the GTIC, check its unique reference number and place the tray as shown on any setting out drawings provided. Always ensure that when installing the GTIC units that they are installed with a slight decline towards the external face of the masonry so that any water will run towards the external face.

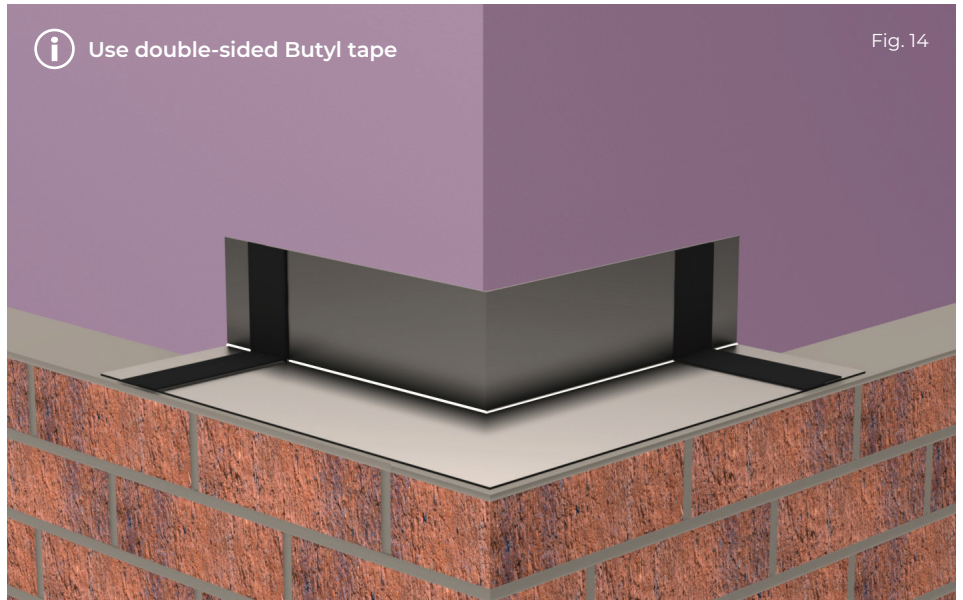

Step 2

Ensure the GTIC is installed 5mm offset from the outer edge of the brickwork. Remove the film from one side of the double-sided Butyl tape and stick the tape along the side edge.

Ensure the Butyl tape is fully adhered to the GTIC. The tape should not overlap the end of the tray.

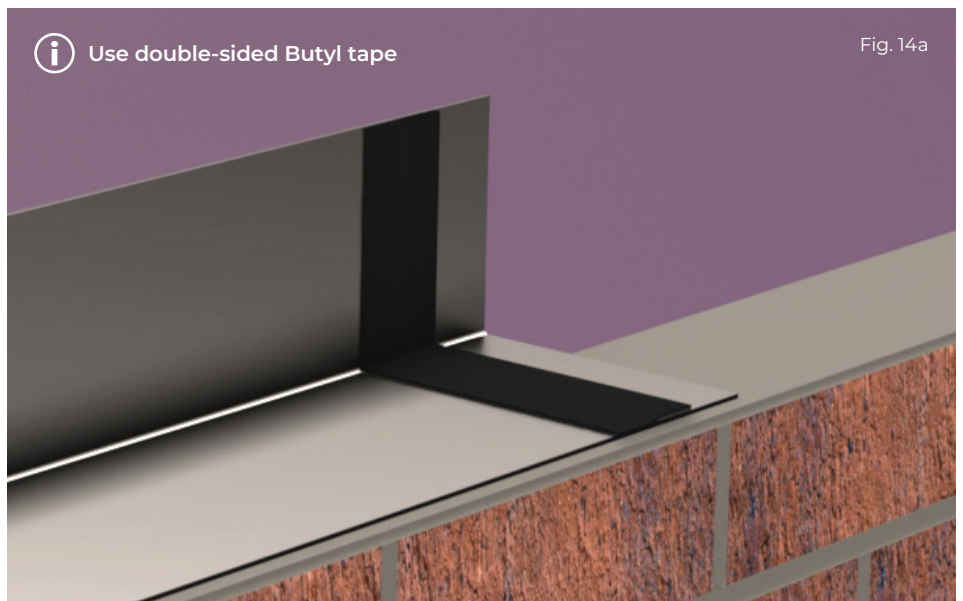

G-Tray™ - Stainless Steel Cavity Tray Corners



Step 3

Remove the remaining film of the double-sided Butyl tape already adhered to the GTIC unit, then place on top while **ensuring a minimum overlap of 50mm**.

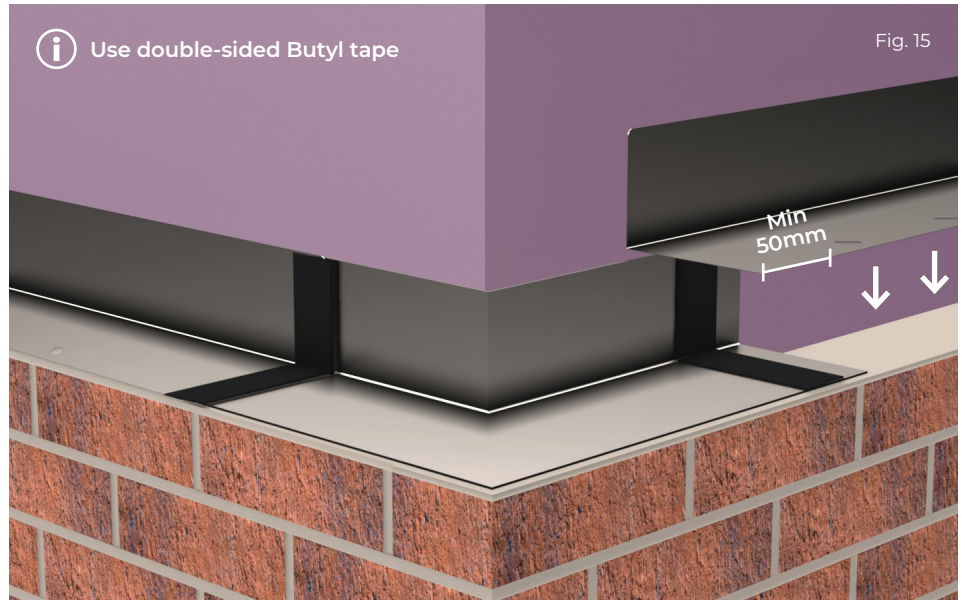

Step 4

Place a strip of single-sided Butyl tape, half overlapping both the GTIC and GTI trays to ensure a waterproof joint.

Ensure the Butyl tape is fully adhered to both GTI units, creating a waterproof joint (Fig. 16).

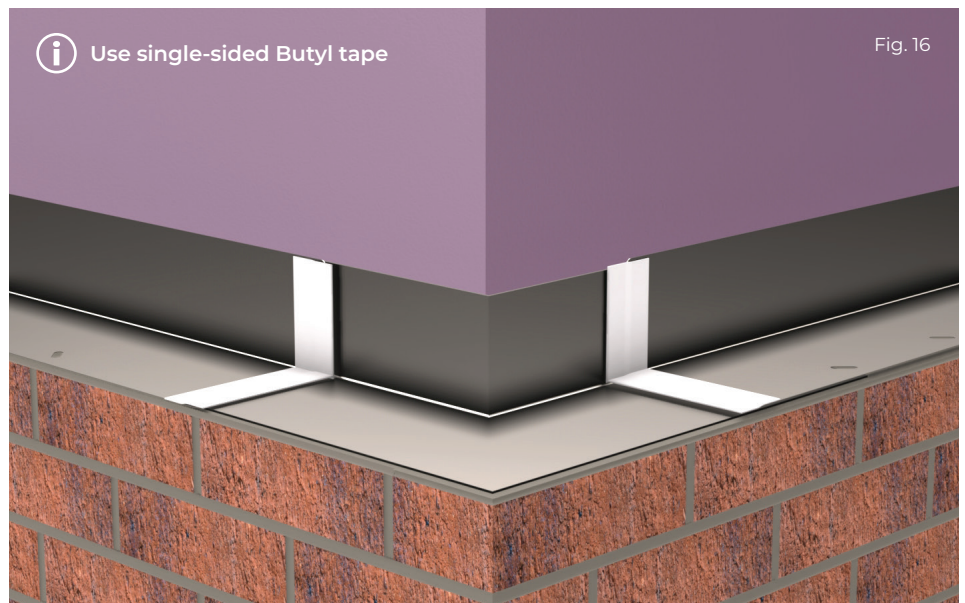

G-Tray™ - Stainless Steel Cavity Tray Corners



Step 5

To secure the GT2C units in place, use ACS approved screws, fixing through the slots within the upstand to the internal structure. The GT2C unit should be fixed at each stud position with **a minimum of three fixings per tray**.

On shorter lengths (under 600mm), this may require two fixings into one stud.

Additional tek screws can be used to ensure joints/ends align fixing back between studs for restraint purposes only (Fig. 17.)

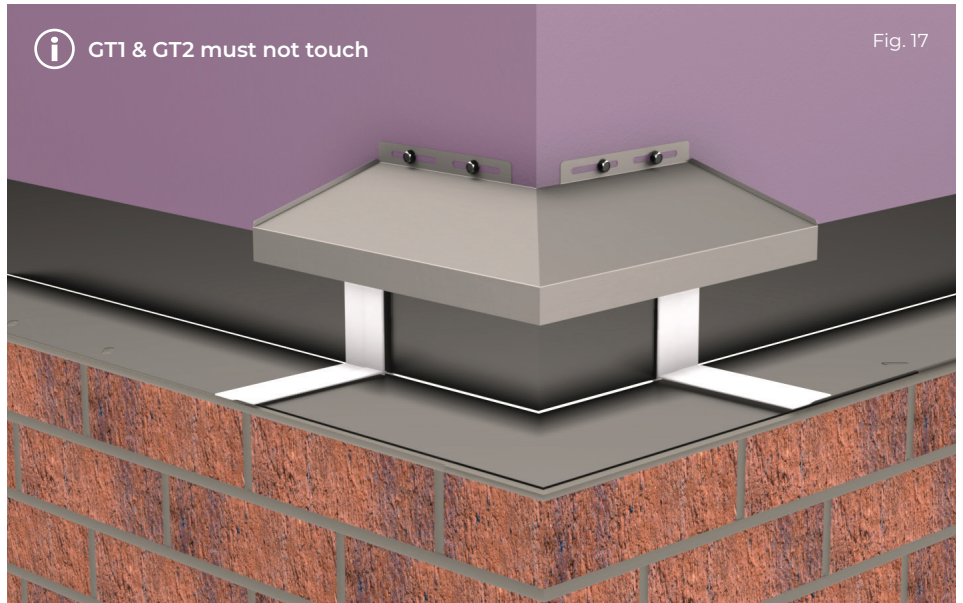

Once the corner is complete, the installer may continue on as outlined in this fitting guide.

For internal corners, the same process should be followed.

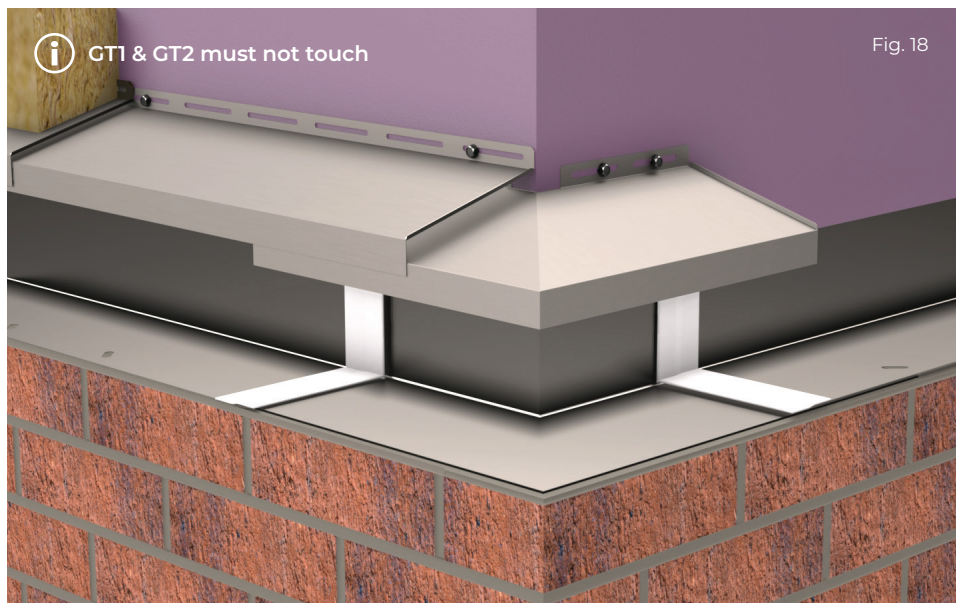

G-Tray™ - Stainless Steel Cavity Tray Corners



Site modifications

The G-Tray™ Stainless Steel Cavity Tray is designed as a two part system. This provides flexibility to overcome site tolerances and cavity fluctuations. G-Tray™ is adaptable on site, minor modifications will not affect the design or waterproofing of the system.

In some instances, the cavity may become smaller than the G-Tray™ system tolerance. Cutting the upstand of the GT2 unit and adapting the system is acceptable, providing full waterproofing is maintained.

Gloves must be worn at all times when handling and installing G-Tray™.

Required tools for installation



Electric
screwdriver/drill



Work
gloves



Slitting shear
(recommended tool for
on-site modifications)

